

## List of standard parts

1

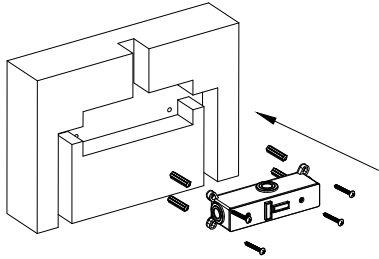

Insert the self-working rubber granules into the hole and fix the reference level of the concealed faucet body with self-working screws to ensure the level. Do not remove the transparent protective cover of the cement wall to avoid the cement splashing on the copper parts (the protection box must be higher than the tile surface).

2

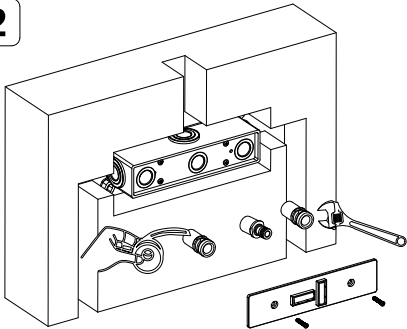

After installing the concealed faucet body, remove the transparent protective cover and install the water inlet connector on the concealed faucet body with a wrench

3

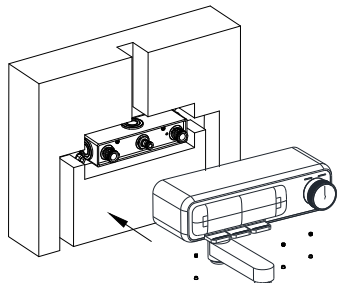

Install the faucet body on the water inlet joint, lock it with hexagonal screws and plug the silicone granule, and the main body of the faucet is installed.

4

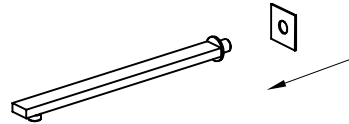

Put the decorative cup over the thread

5

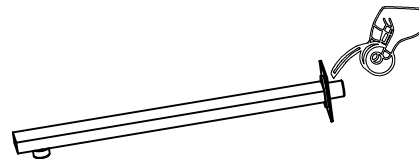

Wrap raw material tape around screw as shown

6

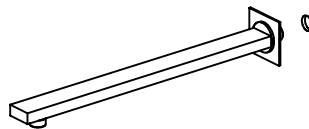

Screw the shower tube onto the thread of the water pipe, installation is completed

7

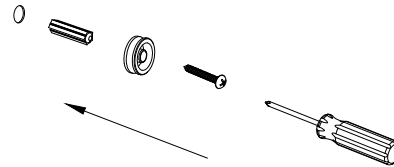

Drill holes according to the required height, insert the self-working rubber granules into the holes and fix the fixings on the wall with self-tapping screws

8

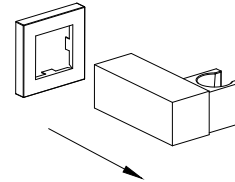

Place the decorative cup over the shower holder

9

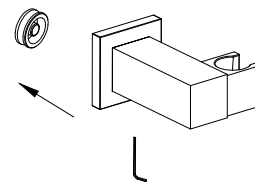

Install the shower holder on the fixed parts, lock the screw with the hex key, and the shower holder is installed.

## List of standard parts

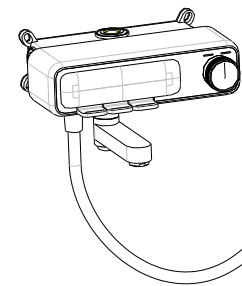
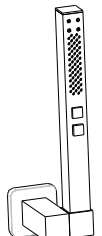
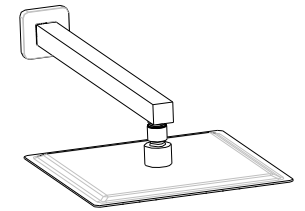

Concealed shower faucet installation completed